

Name: _____

Date: _____

Write the value

Directions: Write the value of the base ten blocks on the line.

Made by: Saddle Up For 2nd Grade

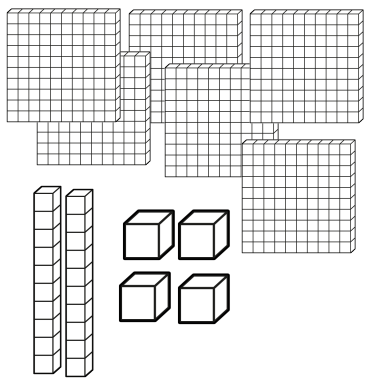

Value

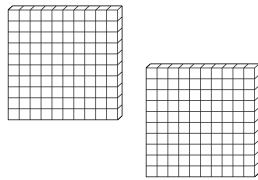

Value

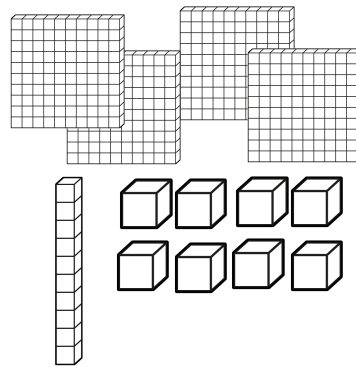

Value

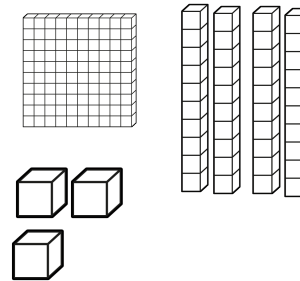

Value

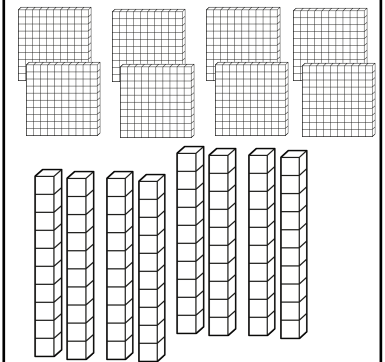

Value

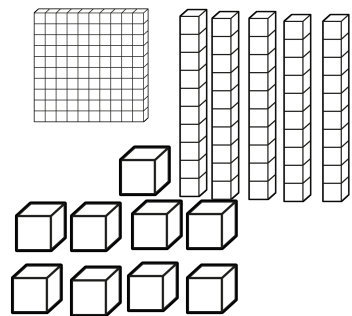

Value

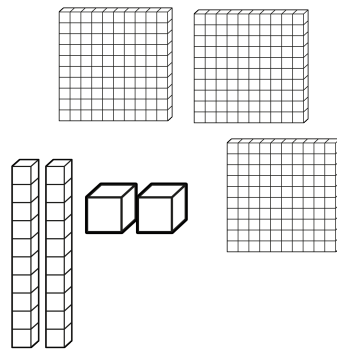

Value

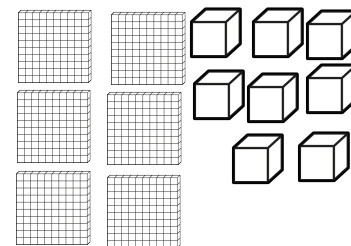

Value

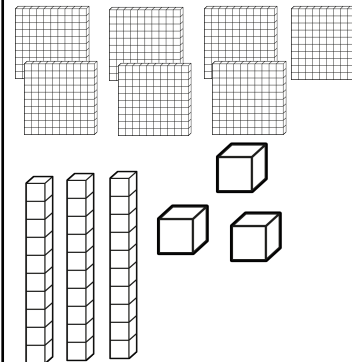

Value

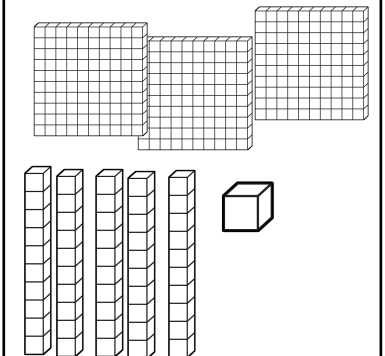

Value

Name: _____

Date: _____

Write the value

Directions: Write the value of the base ten blocks on the line.

Made by: Saddle Up For 2nd Grade

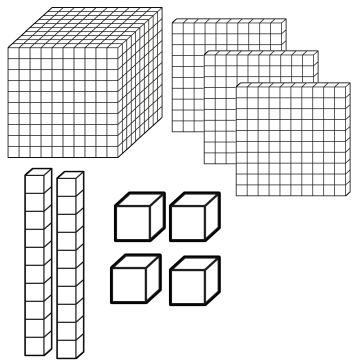

Value

Expand it

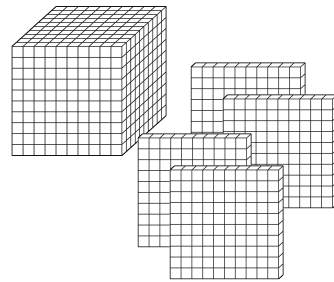

Value

Expand it

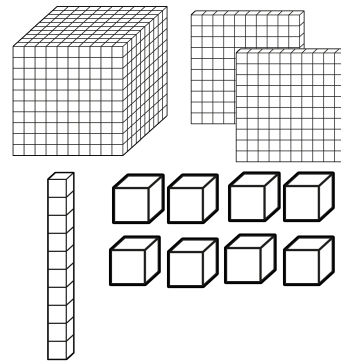

Value

Expand it

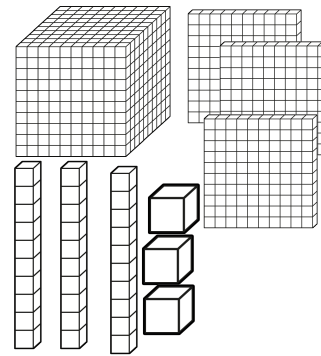

Value

Expand it

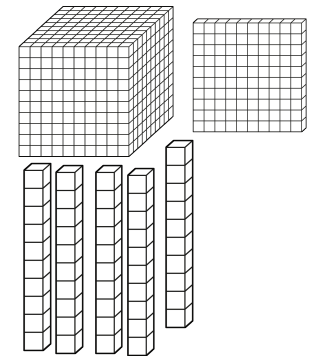

Value

Expand it

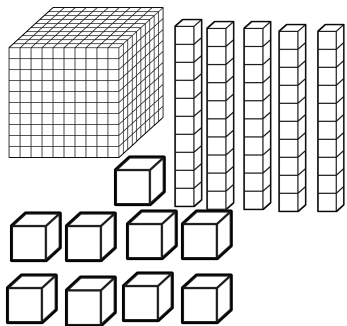

Value

Expand it

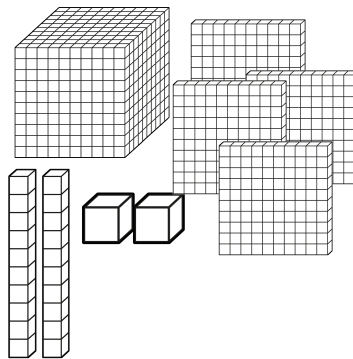

Value

Expand it

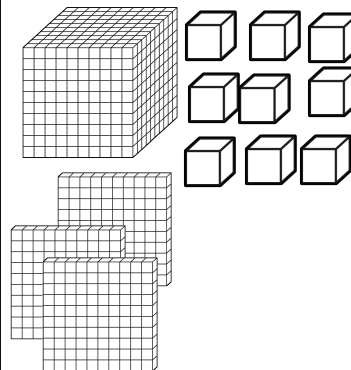

Value

Expand it

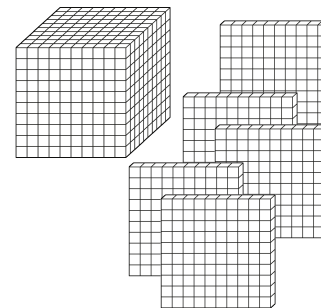

Value

Expand it

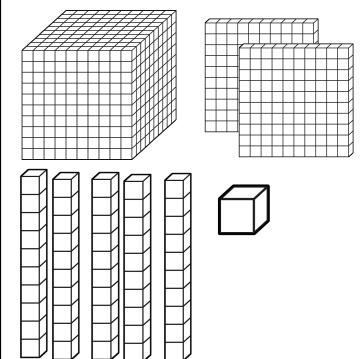

Value

Expand it

Name: _____

Date: _____

Draw the value

Directions: Draw the value of each number in the box.

Made by: Saddle Up For 2nd Grade

387

922

617

505

999

117

248

319

766

850

Name: _____

Date: _____

Draw the value

Directions: Draw the value of each number in the box.

Made by: Saddle Up For 2nd G

1,123

1,087

1,167

1,198

1,074

1,001

1,149

1,177

1,004

1,092

Guided Math: Place Value

- 10 days worth of lesson plans for whole group lessons, independent practice, and small groups.
- Vocabulary posters
- Anchor chart templates
- Interactive notebooks
- Hands on engagement
- Math stations and games
- Craft
- Use ALL YEAR LONG!

Popping into **PLACE VALUE**
a unit to 1,500

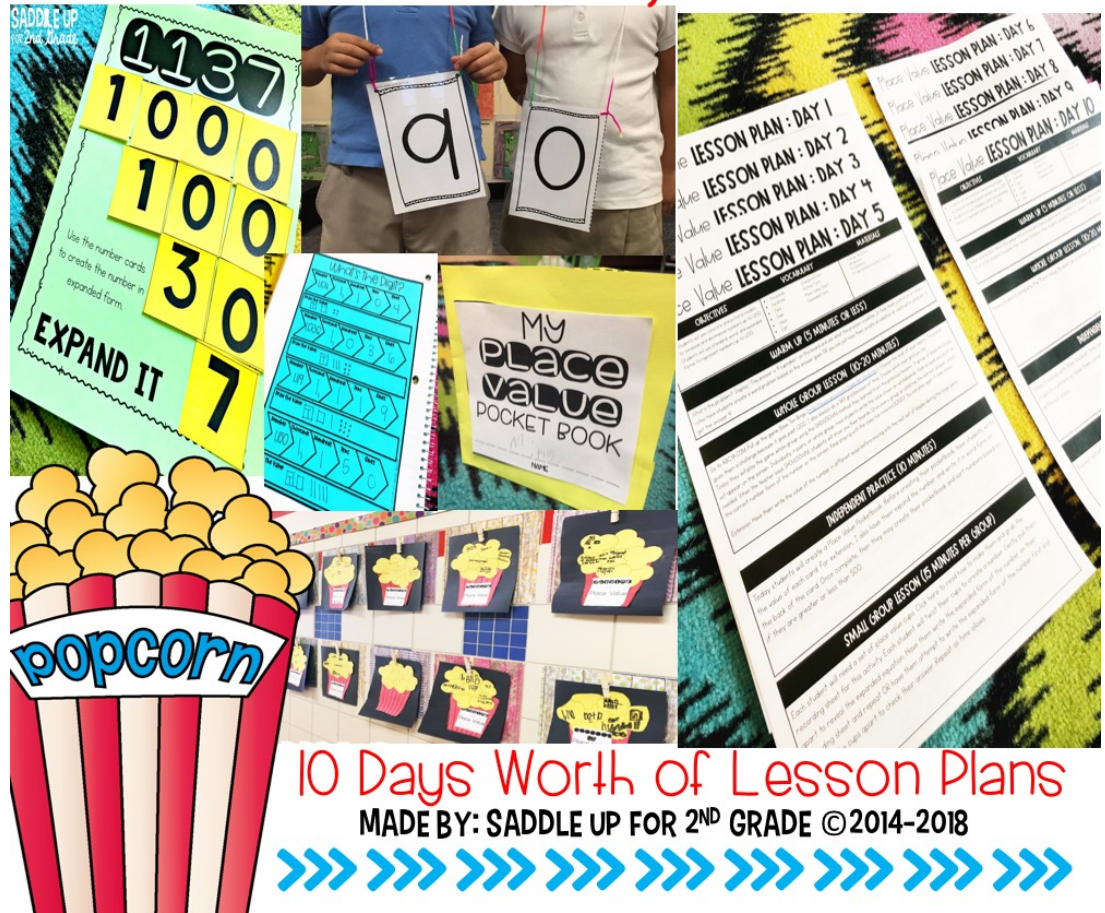

10 Days Worth of Lesson Plans

MADE BY: SADDLE UP FOR 2ND GRADE ©2014-2018

Thank You

Thank you for downloading this resource. I truly appreciate it and hope you love using and implementing it into your classroom. If you have any questions at all or see an error please let me know and I'll be happy to help.



Terms of Use

This product is for single classroom use only. An additional license must be purchased in order to share. If you are NOT the original purchaser, please purchase/download the item from my Teachers Pay Teachers Store before making any copies. Redistributing, editing, selling, or posting this item in any part thereof on the Internet is strictly forbidden. Violations are subject to penalties of the Digital Millennium Copyright Act.

©Saddle Up for 2nd Grade

feedback

Don't forget to leave feedback on this item to score a discount on your future TPT purchases. Click the picture below to find out how.



let's connect

Click the icons below for more products, freebies, and ideas for your classroom!



newsletter

Click the link below to sign up for the latest news from Saddle Up for 2nd Grade including EXCLUSIVE freebies, ideas, activities, and more!

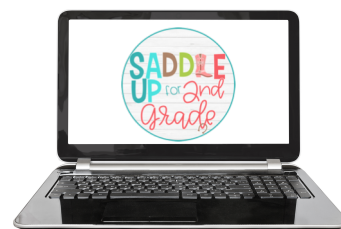

fonts and graphics

Thank you to these artists for creating the beautiful fonts & graphics used in this product.

